



FL-OFFICE.FR  
AMÉNAGEMENT DE BUREAU

# BIQUADRO

## Fiche technique

---



---

contact@bm-bureau.fr -- 01 84 73 00 37 - - 442 rue Fourny 78530 Buc

[www.fl-office.fr](http://www.fl-office.fr)

**COLORI MELAMINICO**

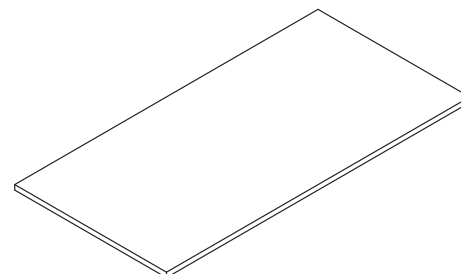

MELAMINE COLOURS

Colore / Colour / Coloris	Variante / Version / Variante
	<b>MBI</b> Bianco / White / Blanc
	<b>LNO</b> Noce Naturale / Natural Walnut / Noyer Naturel
	<b>LRS</b> Rovere Moro / Dark Oak / Chêne Foncé
	<b>QUE</b> Quercia / Oak / Chêne

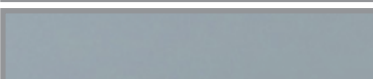

**COLORI GAMBE**

LEGS COLOURS

Colore / Colour / Coloris	Variante / Version / Variante
	<b>BI (RAL 9010)</b> Bianco / White / Blanc
	<b>AL1 (RAL 9022)</b> Alluminio / Aluminium / Aluminium
	<b>TOR (RAL 1019)</b> Tortora / Grey beige / Beige gris
	<b>AS</b> Effetto acciaio satinato / Satin steel effect / Effet acier satine

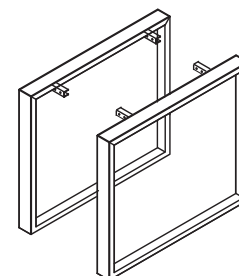

**ACCESSORI (Optional)**

ACCESSORIES (OPTIONAL)

	<b>EC</b> Inserto in vetro Extrachiaro per gamba Extra clear glass insert for leg Insert en verre extra clair pour pied
---	--



LO STESSO COLORE SU MATERIALI DIVERSI NON È DA CONSIDERARSI IDENTICO, MA ABBINABILE  
THE SAME COLOR OVER DIFFERENT MATERIALS SHOULD NOT BE CONSIDERED IDENTICAL, BUT MATCHABLE  
LA MEME COULEUR SUR DES MATERIAUX DIFFERENTS NE DOIT PAS ETRE CONSIDEREE IDENTIQUE, MAIS COORDONNABLE

I COLORI PRESENTI NEL CATALOGO, PER OVVIE RAGIONI DI STAMPA, POSSONO NON CORRISPONDERE A REALTÀ.  
FOR OBVIOUS PRINTING REASONS, THE COLOURS PRESENT IN THE CATALOGUE COULD DIFFER FROM REALITY.  
POUR D'EVIDENTES RAISONS D'IMPRESSION, LES COLORIS DU CATALOGUE POURRAIENT DIFFERER DE LA REALITE.

**FRA**

**BIQUADRO** est une collection de mobilier de bureau opérationnel de Della Rovere en mélamine avec le plan de travail de 2,5 cm et une structure métallique avec pieds cadre de 7 x 3 cm.

**Couleurs disponibles**

- Plans de travail et parties en mélamine: blanc, noyer naturel, chêne foncé, chêne.
- Structure pieds: blanc, aluminium, beige gris et verni effet acier satiné
- Passe-câbles: couleurs neutres, à l'exception du modèle eko-pass et l-pass qui sont disponibles avec le flip dans la même finition du plan de travail melaminé.

**BUREAUX BENCH / TABLE EN LIGNE ET RÉUNION**

1. Les plan de travail sont en aggloméré de bois classe E1 épaisseur 25 mm, revêtu avec particules mélaminées finition à la cire en blanc, érable et noyer.
2. Le périmètre des plans de travail est fini avec chart ABS épaisseur 2 mm., Avec coins arrondis, en observant les règles de sécurité.

**Passe-câble**

Tous les bureaux peuvent être équipés de différents types de passe-câble. Pour commander un bureau avec un passe-câble, vous avez besoin d'identifier le code du bureau, le code du passe-câble avec son emplacement et le type de passe-câble que vous souhaitez installer.

## TAVOLI RIUNIONE

Meeting Table  
Table de reunion

# BIQUADRO

**LNO** **Noce Naturale**  
Natural Walnut  
Noyer Naturel

**LRS** **Rovere Moro**  
Dark Oak  
Chêne Foncé

**QUE** **Quercia**  
Oak  
Chêne

**MBI** **Bianco**  
White  
Blanc

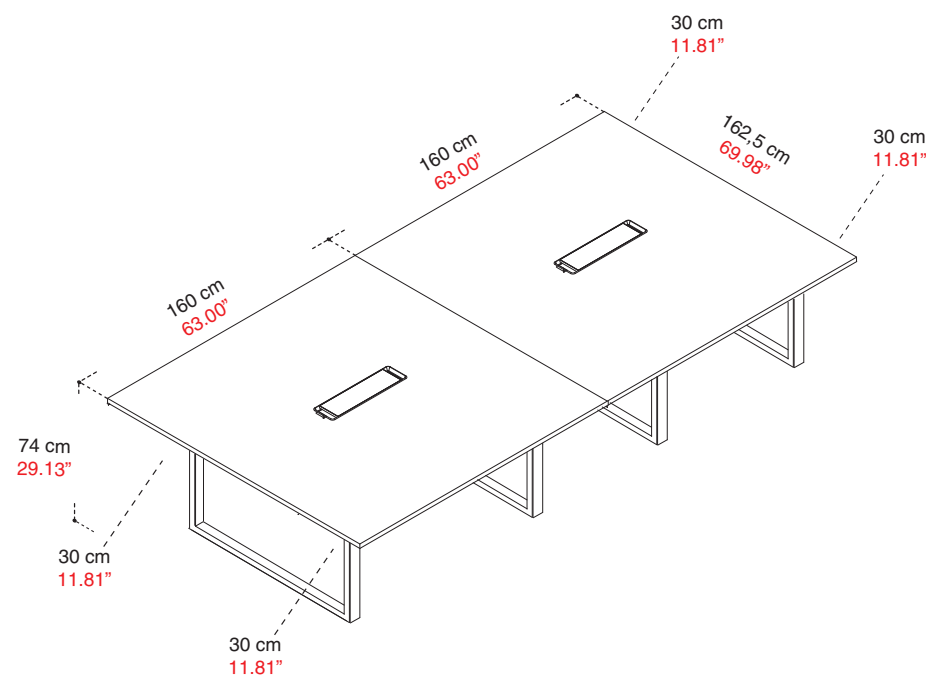
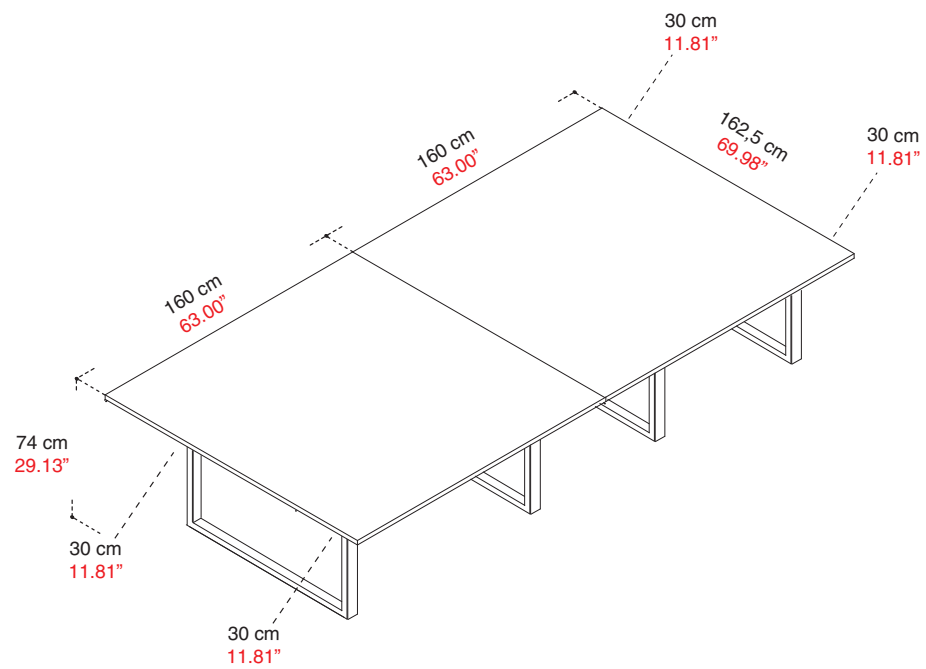

<b>LNO</b> <b>Noce Naturale</b> Natural Walnut Noyer Naturel	<b>LRS</b> <b>Rovere Moro</b> Dark Oak Chêne Foncé	<b>QUE</b> <b>Quercia</b> Oak Chêne	<b>MBI</b> <b>Bianco</b> White Blanc
--	--	---	--

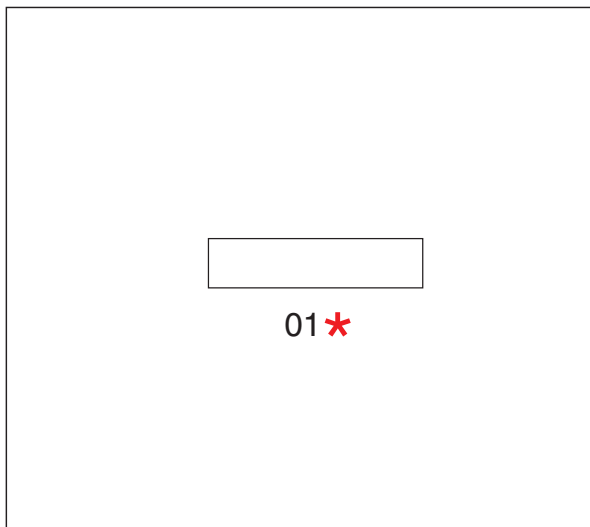

**Si prega di indicare il numero o i numeri dei fori in base alla posizione scelta e ricordarsi di aggiungere il codice del passacavi scelto**

It is necessary to indicate the number/s of drills according to the chosen position and to add the code of the chosen cable-way.

Toujours indiquer le/les numéro/s des trous selon la position choisie et se rappeler ajouter le code du passe-câbles choisi

## PASSACAVI PER TAVOLI RIUNIONE

Cable-way for meeting Table  
Passe-câble pour table de reunion

**BIQUADRO**

### TOP ACCESS SENZA MARSUPIO ECO-PASS

TOP ACCESS ECO-PASS WITHOUT SUPPORT

TOP ACCESS ECO-PASS SANS SUPPORT

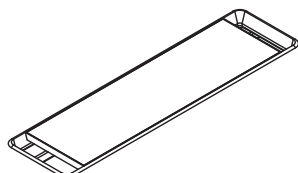

**D269404**

**D269406**

0,2

0,002

1

### TOP ACCESS S/MARSUPIO FINT.MELAMINICO ECO-PASS

TOP ACCESS ECO-PASS MELAMINE LID WITHOUT SUPPORT

TOP ACCESS ECO-PASS SANS SUPPORT AVEC COUVERCLE E

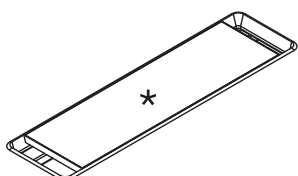

**Coperchio disponibile nelle finiture melaminico bianco, rovere moro, noce naturale, quercia e palissandro. scegliere la variante.**

Lid available in white, natural walnut, dark oak, oak and rosewood melamine finish. Choose the variant.

Couvercle disponible en mélamine blanc, noyer naturel, chêne foncé, chêne, palissandre. Choisissez la variante.

**D269405**

**D269407**

### MARSUPIO PORTACAVI ECO-PASS

CABLE-WAY SUPPORT FOR TOP ACCES ECO-PASS

SUPPORT PASSE-CABLE POUR TOP ACCESS ECO-PASS

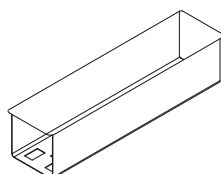

**D268208**

### TOP ACCESS I-PASS CON FINITURA TOP MELAMINICO

TOP ACCESS I-PASS MELAMINE LID

TOP ACCESS I-PASS COUVERLCLE EN FINITION MELAMINE

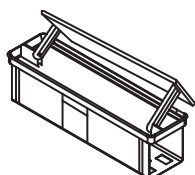

**D269400**

Tutto alluminio

**D269401 LNO**

Alluminio coperchio finitura noce

**D269401 LRS**

Alluminio coperchio finitura rov. scuro

**D269401 MBI**

Alluminio coperchio finitura bianco

**D269401 QUE**

Alluminio coperchio finitura quercia

### PASSACAVI EKO-PASS

Eko-pass cable-way  
Passe-câble eko-pass

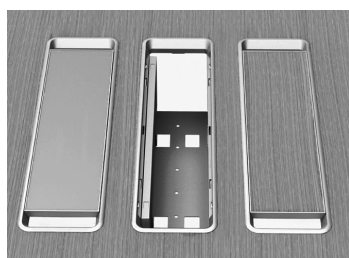

### PASSACAVI I-PASS

I-pass cable-way  
Passe-câble I-pass

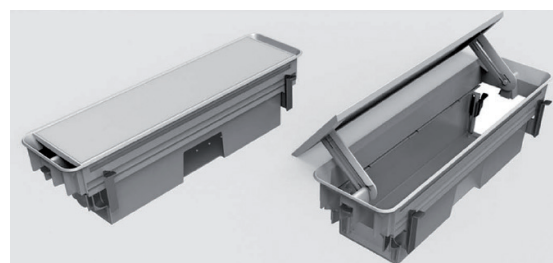

# BIQUADRO

## TAVOLI RIUNIONE

Meeting Table  
Table de reunion

**LNO** **Noce Naturale**  
Natural Walnut  
Noyer Naturel

**LRS** **Rovere Moro**  
Dark Oak  
Chêne Foncé

**QUE** **Quercia**  
Oak  
Chêne

**MBI** **Bianco**  
White  
Blanc

**Foro e top access pagina 21-22**  
Hole and top access page 21-22  
Trou et top access page 21-22

