

# DEEN A

## descriptif technique





---

## **Informations générales :**

### **Garantie :**

Produits .mdd - **5 ans**

Composants électriques et tissus - **2 ans.**

### **Mélangé - certifié :**



### **Montage :**

livrée en pièces détachées

### **Emballage :**

carton, enveloppe en plastique perforé

### **Conforme aux normes :**

PN-EN 527-2:2017-02

### **Densité du panneau :**

12 mm - 690 - 750 kg/m<sup>3</sup>

18 mm - 650 - 690 kg/m<sup>3</sup>

28 mm - 610 - 630 kg/m<sup>3</sup>

36 mm - 610 - 630 kg/m<sup>3</sup>

## Plateaux bureaux Ogi

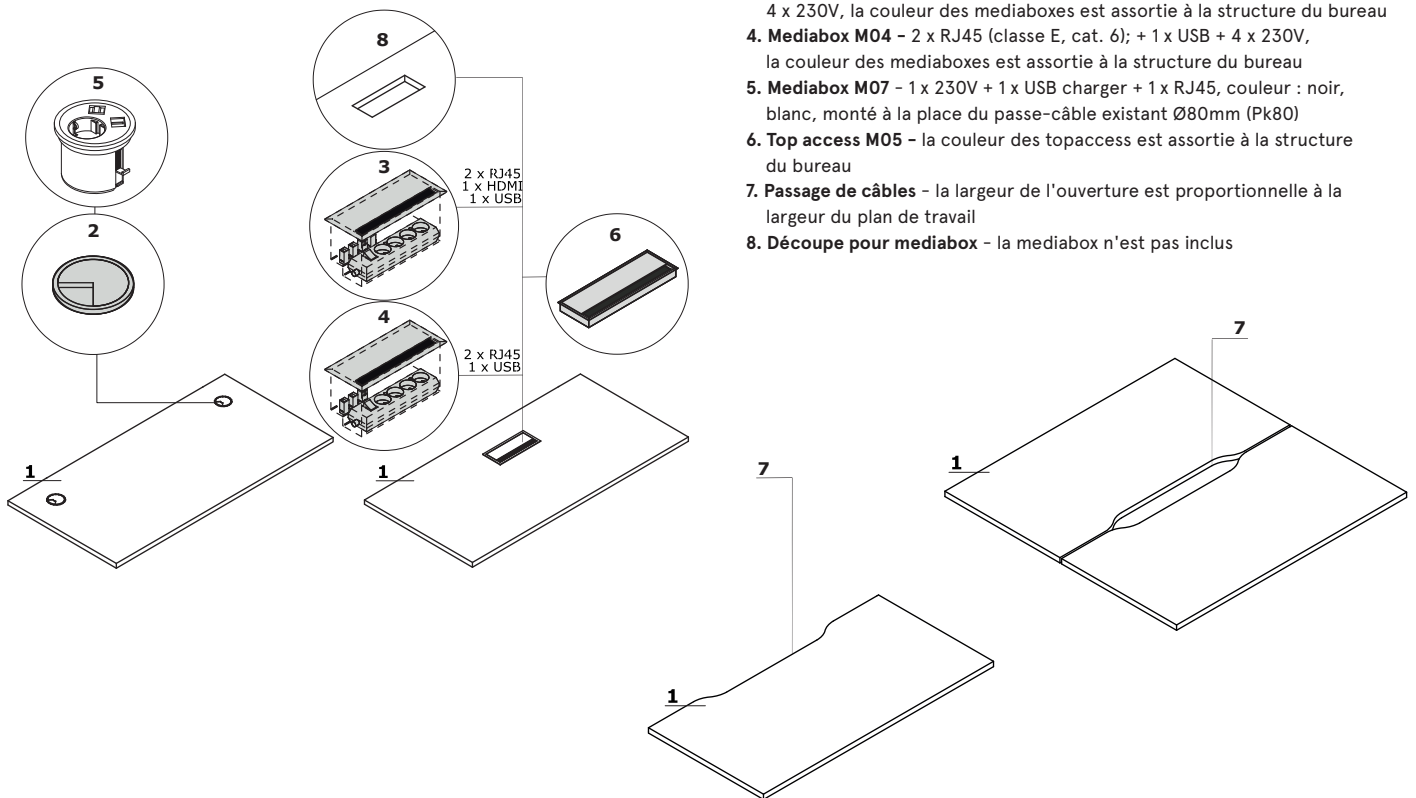

## Dimensions des surfaces de travail (mm)

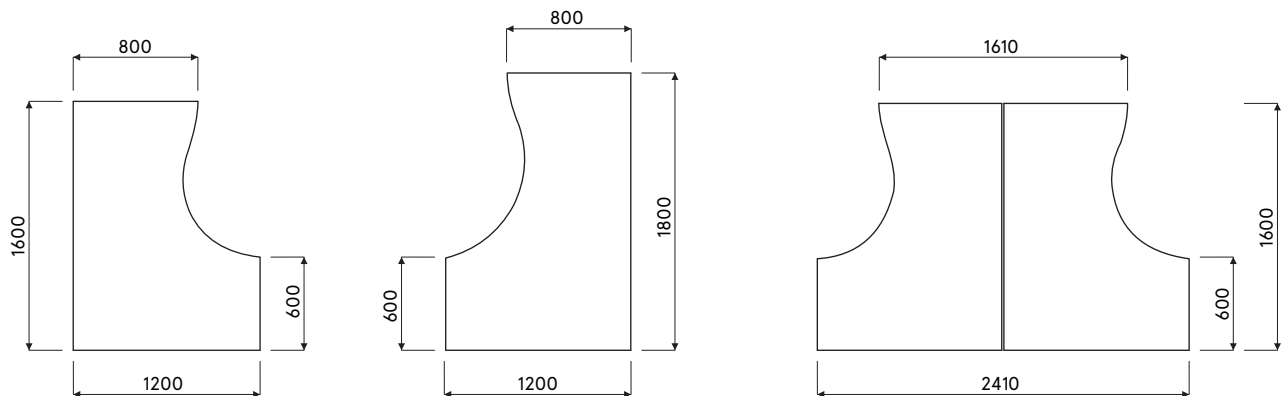

## Piètement

Ogi A: métal peinture poudre époxy, profil 60x30 mm

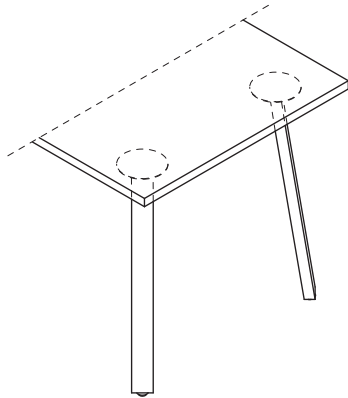

Attention - le chemin de câbles situé sous le plan de travail est uniquement disponible en : M009 - couleur aluminium semi-mat

## Accessoires

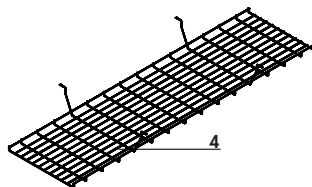
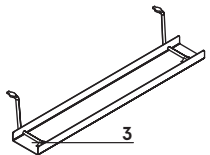
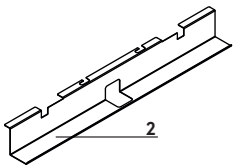
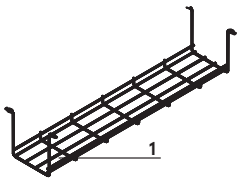

1. **Chemin de câbles S69** - métal finition peinture poudre époxy, couleur 09 - aluminium
2. **Chemin de câbles (SG12, SG16)** - pour bureau individuel, métal finition peinture poudre époxy, couleur M009 - aluminium semi-mate
3. **Chemin de câbles E64** - métal finition peinture poudre époxy, couleur M009 - aluminium semi-mate
4. **Chemin de câbles pour bench Ogi (SG220, SG260)** - fil acier Ø4 mm, métal finition peinture poudre époxy, couleur : 09 - aluminium

---

## Bureaux droits \*



**BAG026**  
1200 / 600 / 740  
25 kg



**BAG036**  
1400 / 600 / 740  
26 kg



**BAG046**  
1600 / 600 / 740  
27.6 kg



**BAG027**  
1200 / 700 / 740  
24 kg



**BAG037**  
1400 / 700 / 740  
27 kg



**BAG047**  
1600 / 700 / 740  
29 kg



**BAG028**  
1200 / 800 / 740  
27 kg

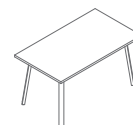

**BAG038**  
1400 / 800 / 740  
29 kg

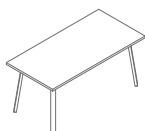

**BAG048**  
1600 / 800 / 740  
32 kg

---

## Bureaux compacts \*

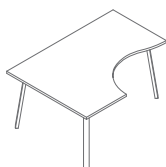

**BAG10**  
1600 / 1200 / 740  
37 kg

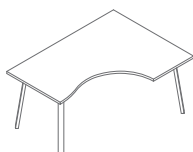

**BAG11**  
1600 / 1200 / 740  
37 kg

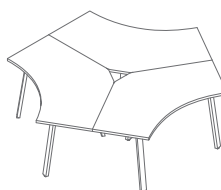

**BAG12**  
2343 / 2029 / 740  
93.6 kg

---

## Benches \*

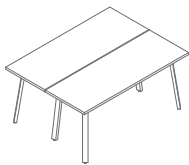

**BAG0214**  
1600 / 1210 / 740  
48 kg

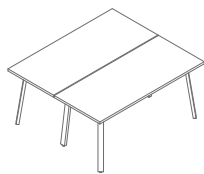

**BAG0216**  
1600 / 1410 / 740  
54 kg

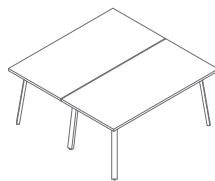

**BAG0218**  
1600 / 1610 / 740  
60 kg

---

## Élément suivant - pour multiplier les postes \*

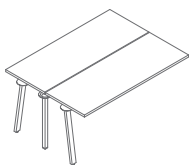

**BAG0414**  
1600 / 1210 / 740  
42 kg

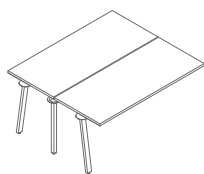

**BAG0416**  
1600 / 1410 / 740  
48 kg

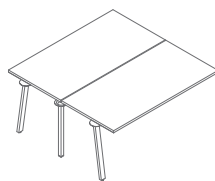

**BAG0418**  
1600 / 1610 / 740  
54 kg

---

## Plateau



## Passes câbles

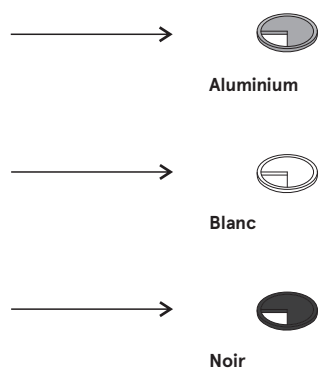

## Piètement, mediabox - métal

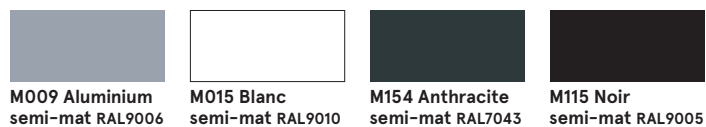

\* corps - groupe II